

1 ROHS Compliant

7	DATE	2012/07/23
	Revision	A

- Features :
- T-568A/B Dual wiring
  - RJ45 complies with FCC part 68 standard
  - 110/Krone dual IDC connector compatible
  - Provides termination for 22~26 AWG wire
  - Jack insertion life >750 mating cycles
  - IDC insertion life >250 mating cycles
  - Operating temperature : -40 °C ~ +60 °C
- Electrical :
- Contact resistance : 20m ohm
  - DC Current rating : 1.5Amps
  - DC resistance : Max.0.1 ohm
  - Insulation Resistance : 500m ohm
  - Dielectric withstanding voltage : 1000V

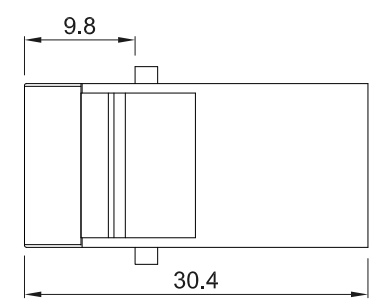
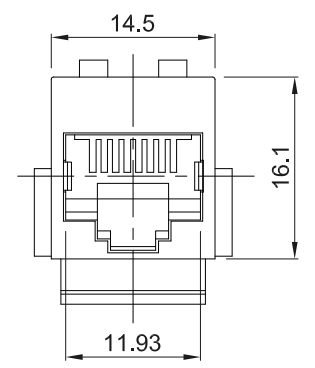
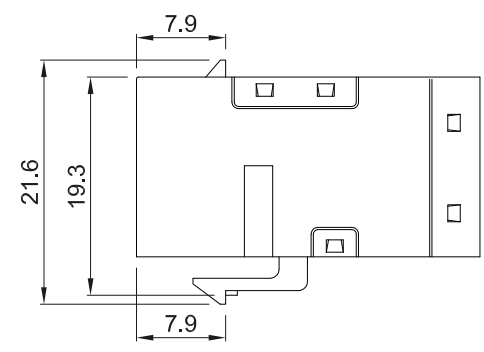
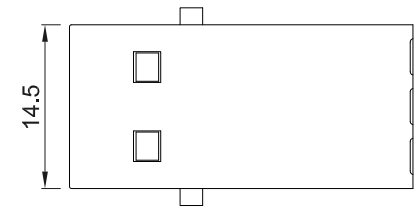
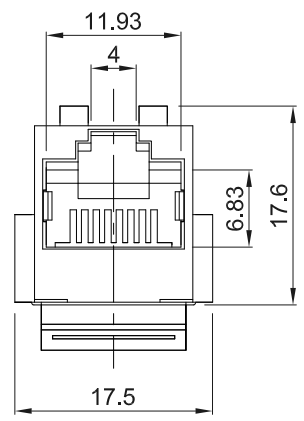

TOLERANCE	
.XXXX	----
.XXX	0.10
.XX	0.25
.X	0.38

MATERIAL	
CATEGORY	<input checked="" type="checkbox"/> CAT.5E <input type="checkbox"/> CAT.6 <input type="checkbox"/> CAT.3 <input type="checkbox"/> OTHER _____
HOUSING	ABS UL94V-0
CONTACT	0.35 mm DIAMETER PHOSPHOR BRONZE GOLD PLATED OVER NICKEL
GOLD-PLATING	<input type="checkbox"/> 0.0762um/3u inch <input type="checkbox"/> 0.15um/6u inch <input type="checkbox"/> 0.38um/15u inch <input type="checkbox"/> 0.76um/30u inch <input checked="" type="checkbox"/> 1.27um/50u inch
COLOR	<input type="checkbox"/> WHITE <input type="checkbox"/> BLACK <input type="checkbox"/> GREEN <input type="checkbox"/> BLUE <input type="checkbox"/> YELLOW <input type="checkbox"/> RED <input type="checkbox"/> ORANGE <input type="checkbox"/> IVORY <input type="checkbox"/> OTHER _____
TYPE OF PRODUCT	<input type="checkbox"/> UNSHIELD <input checked="" type="checkbox"/> SHIELD : 0.25mm THICKNESS COPPER ALLOY WITH NICKLE PLATED.

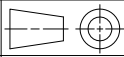
<b>P/NO. NKSJ-FTP-C5e-N</b>		
ITEM. Inline Coupler	CO. SY	S/N. NKSJ-FTP-C5e-N
DR. Wakka 2012/07/23	APPD.	CHKD.
 NEX1 Technologies Co., Ltd TEL: (02) 2518-1300 FAX: (02) 2501-4209		FILE. NKSJ-FTP-C5e-N
		SCALE / 
		UNIT mm SIZE A4

REV.	DESCRIPTION	ENG.	APPROVAL
1	2	3	4